

Digital Transistors (Built-in Resistors)

EMD6 Dual Digital Transistors (NPN+PNP)

FEATURES

- DTA143T(PNP) and DTC143T(NPN) transistors are built-in a package.
- Transistor elements are independent, eliminating interference.
- Mounting cost and area can be cut in half.

MARKING:D6

Absolute maximum ratings(Ta=25°C)

| Parameter | Symbol | Limits | Unit |
|-----------------------------|---------------|---------|------|
| Collector-base voltage | $V_{(BR)CBO}$ | 50 | V |
| Collector-emitter voltage | $V_{(BR)CEO}$ | 50 | V |
| Emitter-base voltage | $V_{(BR)EBO}$ | 5 | V |
| Collector current | I_C | 100 | mA |
| Collector Power dissipation | P_C | 150 | mW |
| Junction temperature | T_j | 150 | °C |
| Storage temperature | T_{stg} | -55~150 | °C |

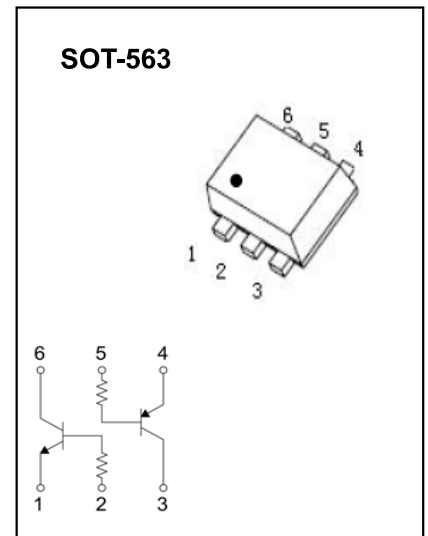

Electrical characteristics (Ta=25°C)

| Parameter | Symbol | Min. | Typ | Max. | Unit | Conditions |
|--------------------------------------|---------------|------|-----|------|------------|----------------------------------|
| Collector-base breakdown voltage | $V_{(BR)CBO}$ | 50 | | | V | $I_C=50\mu A$ |
| Collector-emitter breakdown voltage | $V_{(BR)CEO}$ | 50 | | | V | $I_C=1mA$ |
| Emitter-base breakdown voltage | $V_{(BR)EBO}$ | 5 | | | V | $I_E=50\mu A$ |
| Collector cut-off current | I_{CBO} | | | 0.5 | μA | $V_{CB}=50V$ |
| Emitter cut-off current | I_{EBO} | | | 0.5 | μA | $V_{EB}=4V$ |
| Collector-emitter saturation voltage | $V_{CE(sat)}$ | | | 0.3 | V | $I_C=5mA, I_B=0.25mA$ |
| DC current transfer ratio | h_{FE} | 100 | | 600 | | $V_{CE}=5V, I_C=1mA$ |
| Input resistance | R_1 | 3.29 | 4.7 | 6.11 | K Ω | |
| Transition frequency | f_T | | 250 | | MHz | $V_{CE}=10V, I_E=-5mA, f=100MHz$ |

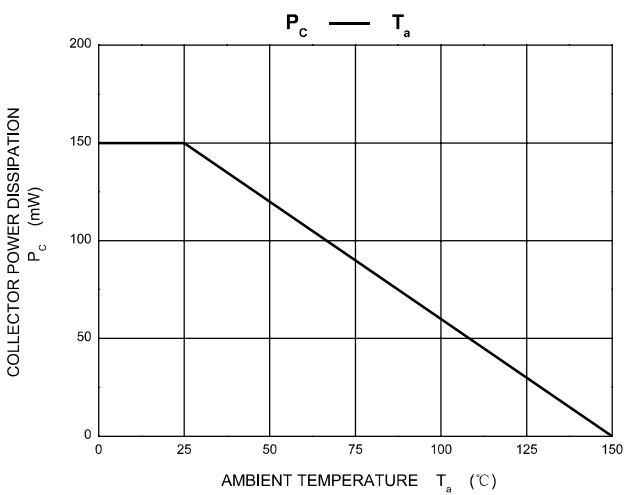
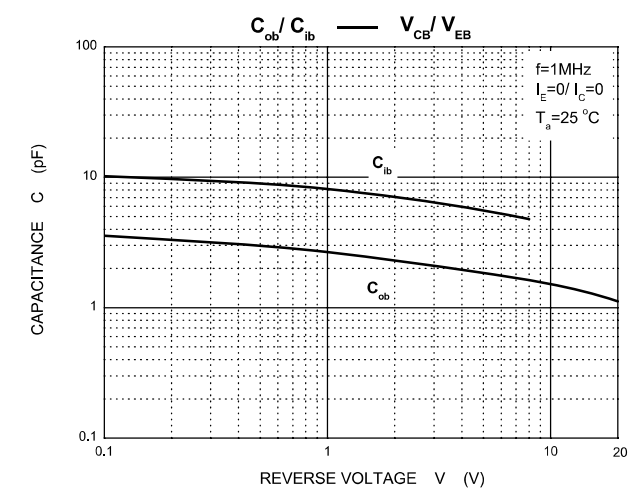
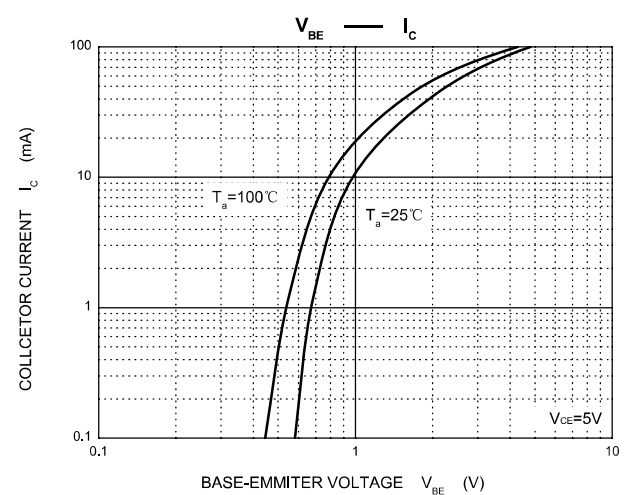
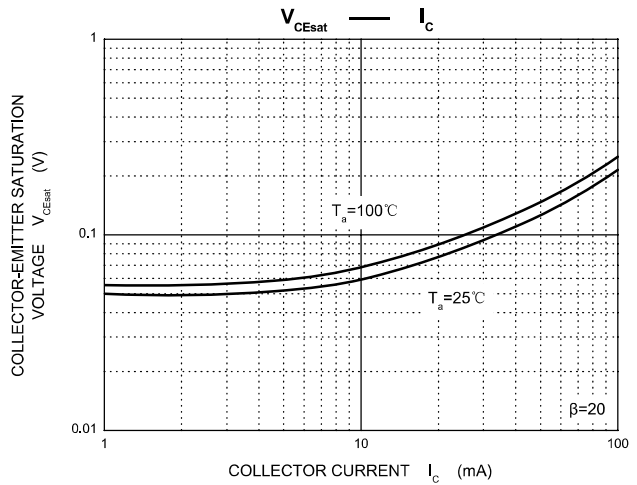
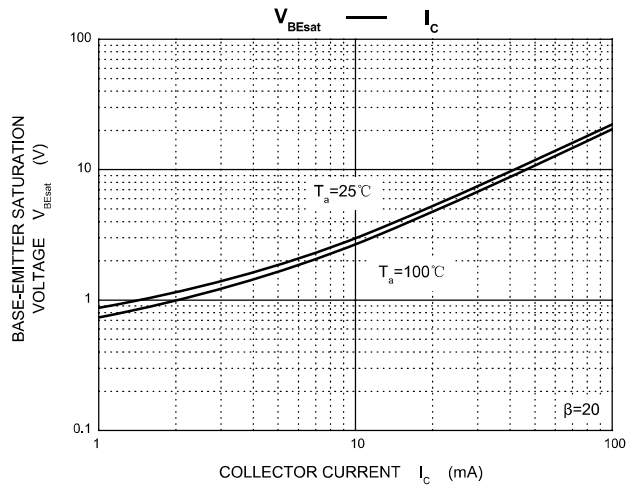
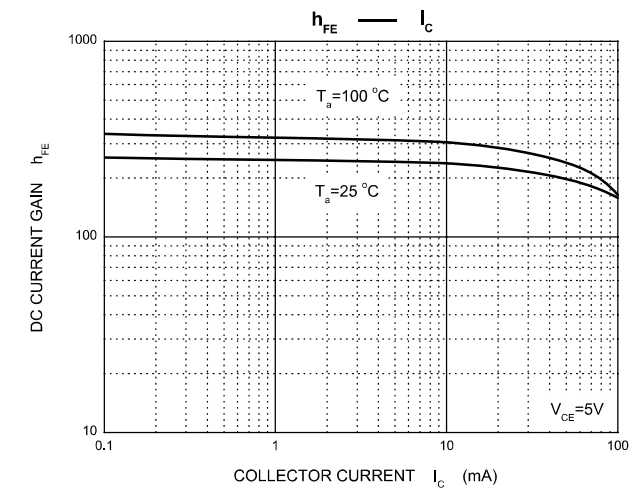
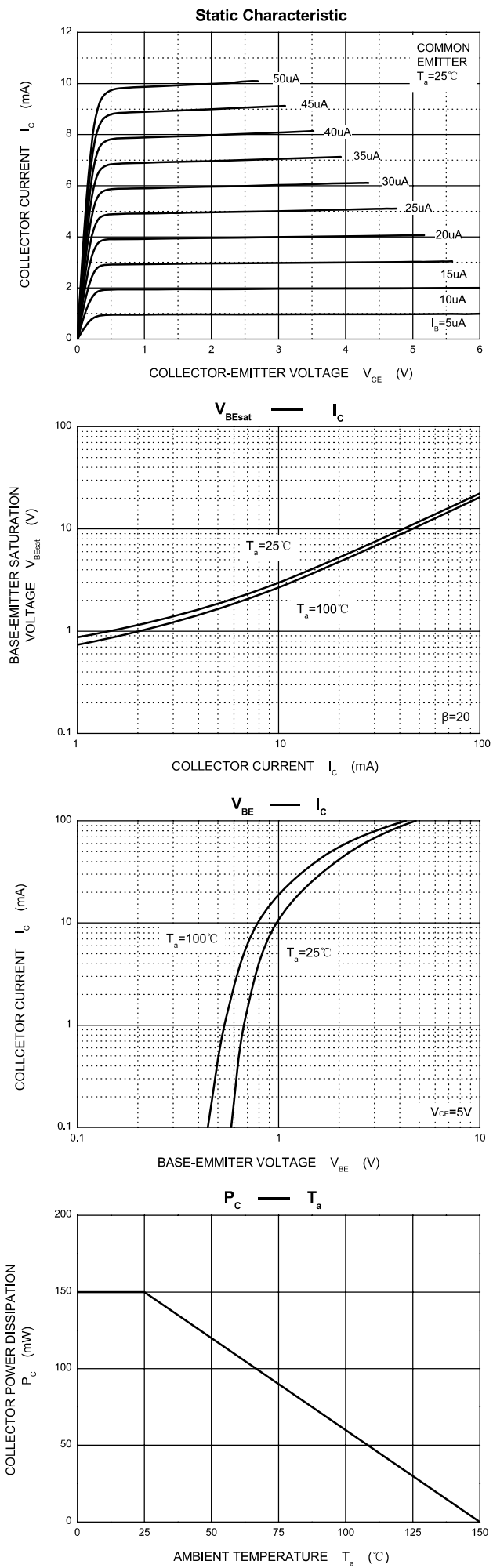

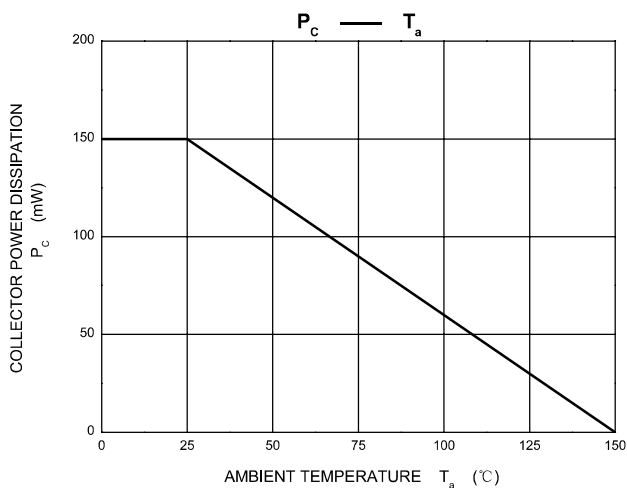
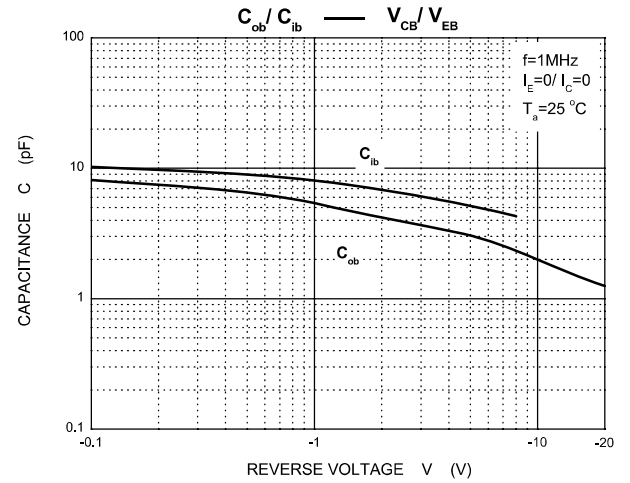
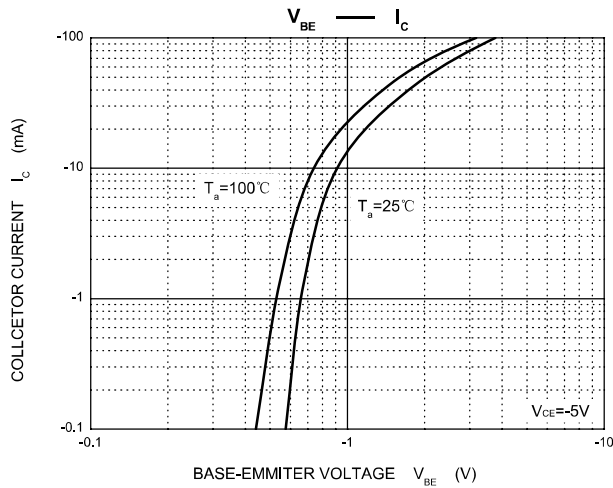
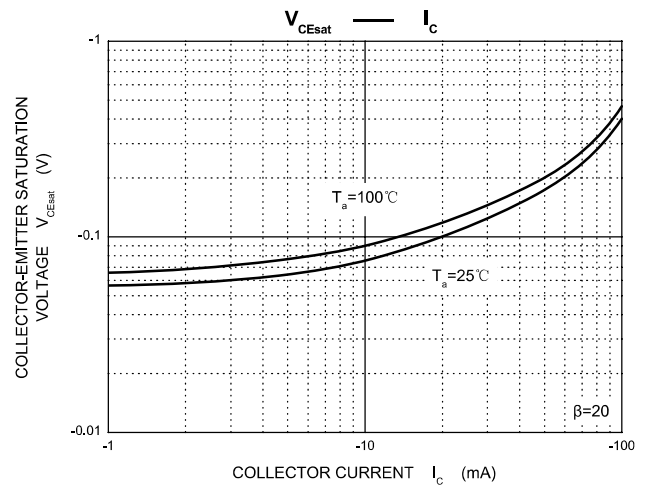
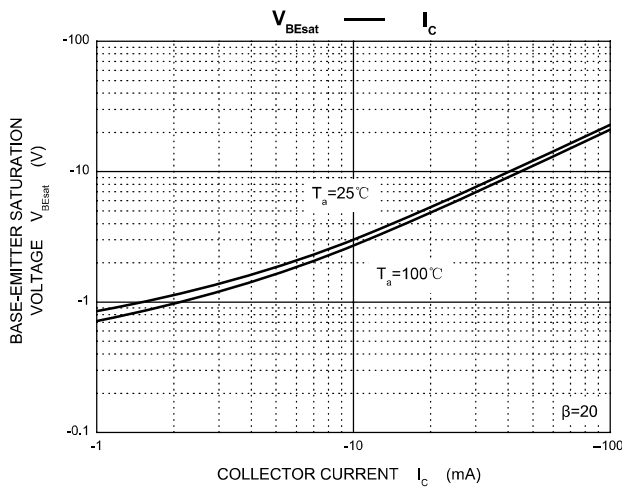
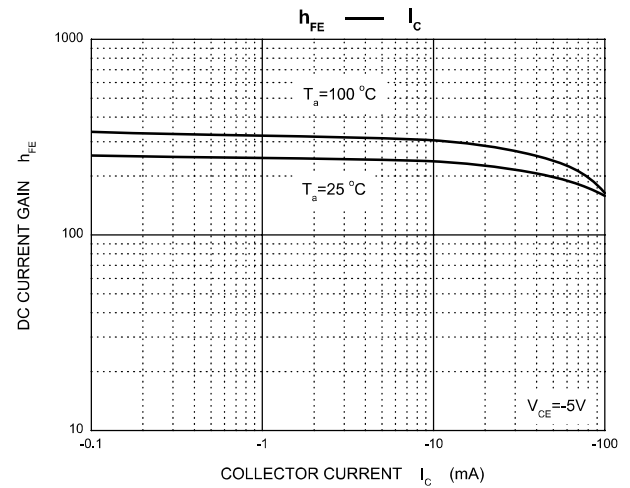
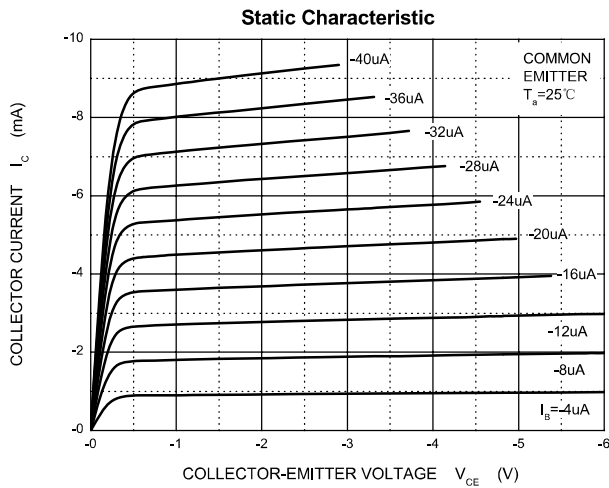

SOT-563 Package Outline Dimensions

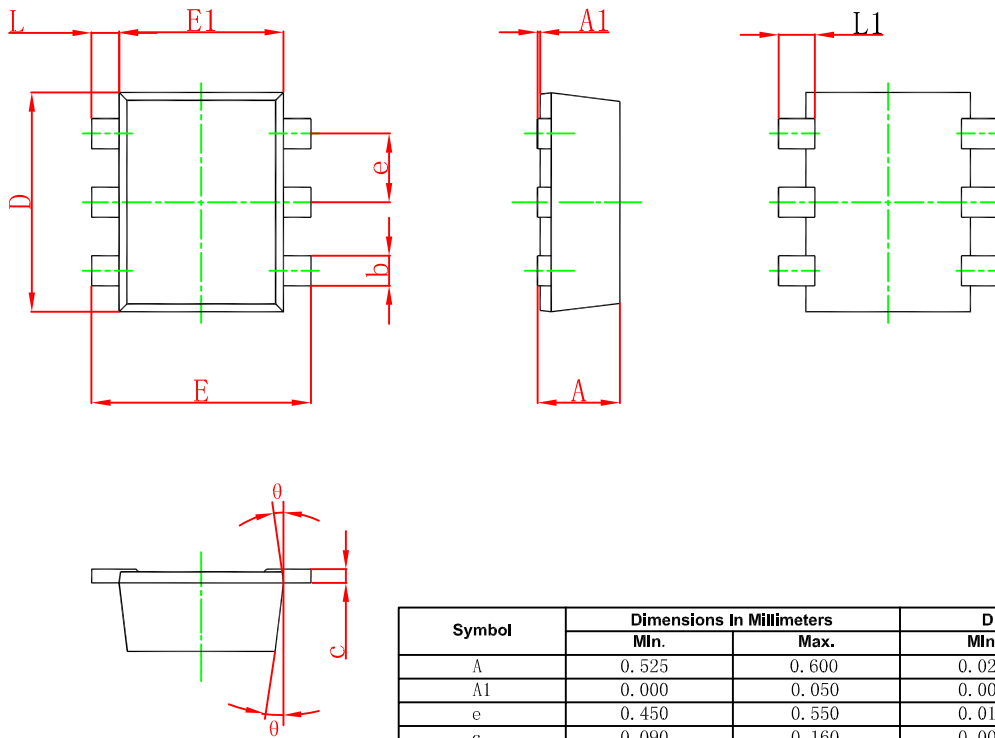

| Symbol | Dimensions In Millimeters | | Dimensions In Inches | |
|--------|---------------------------|-------|----------------------|-------|
| | Min. | Max. | Min. | Max. |
| A | 0.525 | 0.600 | 0.021 | 0.024 |
| A1 | 0.000 | 0.050 | 0.000 | 0.002 |
| e | 0.450 | 0.550 | 0.018 | 0.022 |
| c | 0.090 | 0.160 | 0.004 | 0.006 |
| D | 1.500 | 1.700 | 0.059 | 0.067 |
| b | 0.170 | 0.270 | 0.007 | 0.011 |
| E1 | 1.100 | 1.300 | 0.043 | 0.051 |
| E | 1.500 | 1.700 | 0.059 | 0.067 |
| L | 0.100 | 0.300 | 0.004 | 0.012 |
| L1 | 0.200 | 0.400 | 0.008 | 0.016 |
| θ | 7 °REF. | | 7 °REF. | |

SOT-563 Suggested Pad Layout

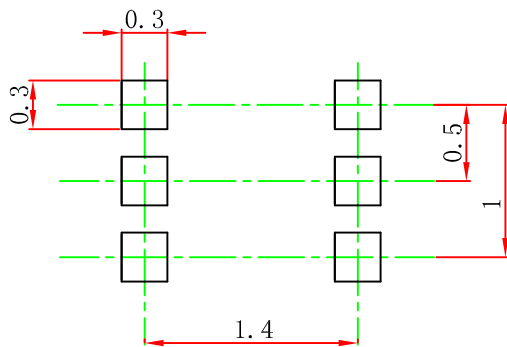

- Note:
1. Controlling dimension: in millimeters.
 2. General tolerance: $\pm 0.05\text{mm}$.
 3. The pad layout is for reference purposes only.

NOTICE

JCET reserve the right to make modifications, enhancements, improvements, corrections or other changes without further notice to any product herein. JCET does not assume any liability arising out of the application or use of any product described herein.

SOT-563 Tape and Reel

SOT-563 Embossed Carrier Tape

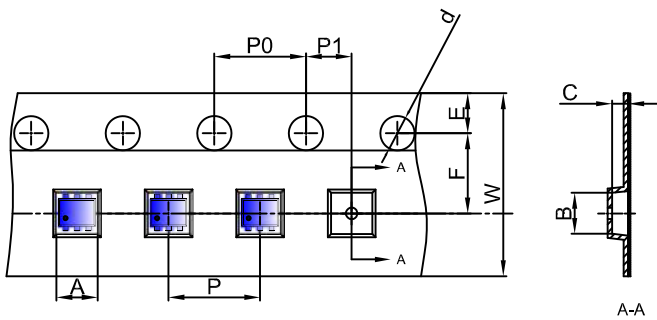

Packaging Description:
 SOT-563 parts are shipped in tape. The carrier tape is made from a dissipative (carbon filled) polycarbonate resin. The cover tape is a multilayer film (Heat Activated Adhesive in nature) primarily composed of polyester film, adhesive layer, sealant, and anti-static sprayed agent. These reeled parts in standard option are shipped with 3,000 units per 7" or 17.8cm diameter reel. The reels are clear in color and is made of polystyrene plastic (anti-static coated).

| Dimensions are in millimeter | | | | | | | | | | |
|------------------------------|------|------|------|-------|------|------|------|------|------|------|
| Pkg type | A | B | C | d | E | F | P0 | P | P1 | W |
| SOT-563 | 1.78 | 1.78 | 0.69 | Ø1.50 | 1.75 | 3.50 | 4.00 | 4.00 | 2.00 | 8.00 |

SOT-563 Tape Leader and Trailer

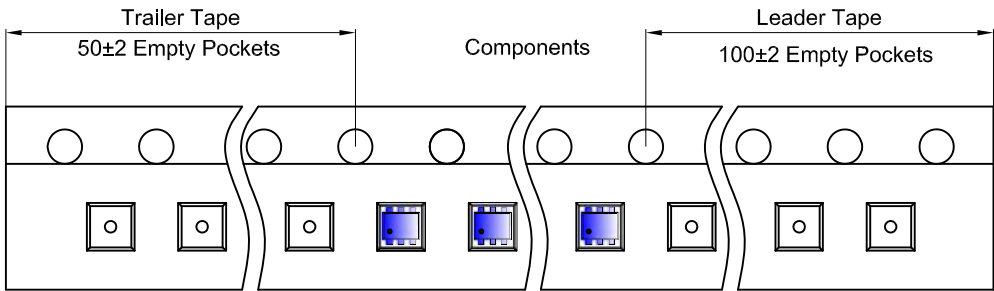

SOT-563 Reel

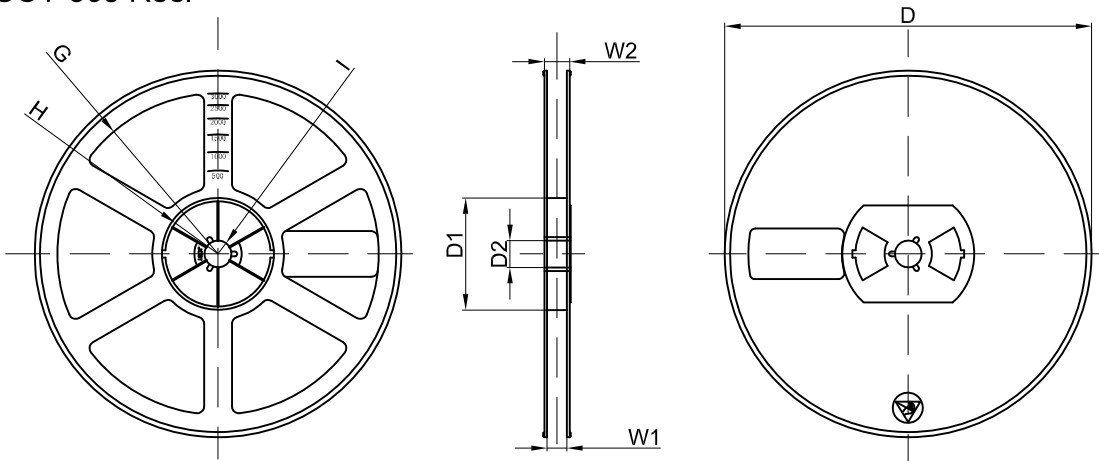

| Dimensions are in millimeter | | | | | | | | |
|------------------------------|---------|-------|-------|--------|--------|-------|------|-------|
| Reel Option | D | D1 | D2 | G | H | I | W1 | W2 |
| 7" Dia | Ø178.00 | 54.40 | 13.00 | R78.00 | R25.60 | R6.50 | 9.50 | 12.30 |

| REEL | Reel Size | Box | Box Size(mm) | Carton | Carton Size(mm) | G.W.(kg) |
|----------|-----------|------------|--------------|-------------|-----------------|----------|
| 3000 pcs | 7 inch | 45,000 pcs | 203×203×195 | 180,000 pcs | 438×438×220 | |